



TC 12E-22E

tritacarne meat grinders

- Costruzione in alluminio pressofuso lucidato.
- Riduttore tritacarne a bagno d'olio.
- Bocca ed elica tritacarne in ghisa trattata per uso alimentare, su richiesta anche in acciaio inox Aisi 304.
- Piastra e coltello inox.

Versione CE con:

- Comandi IP54 con NVR.

Opzioni:

- Comandi con inversione.

- Polished die-cast aluminum construction.
- oil bath gearbox meat grinder.
- Mouth and propeller mincer in untreated cast iron for food, on request in Aisi 304 stainless steel.
- S7steel plate and knife.

CE version with:

- IP54 protection rated controls and NVR device.

Optionals:

- Reverse.









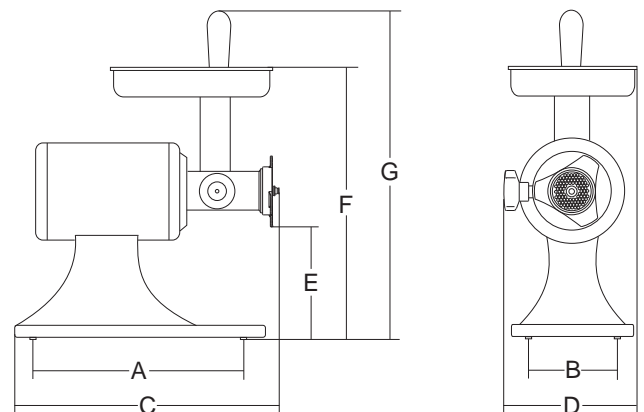







Passapomodoro per TC/TCG 12E
Tomato press for TC / TCG 12E



Passapomodoro per TC/TCG 22E
Tomato press for TC / TCG 22E



														
	watt/Hp	Kg/10 min.	ø mm	mm	mm	mm	mm	mm	mm	mm	mm	kg	mm	kg
TC 12 E	735/1	1ph/3ph	25	4.5	225	185	430	215	140	445	520	18	320x460x470	20
TC 22 E	800/1,2	1ph/3ph	33	4.5	225	185	440	215	135	445	520	21	320x460x470	23